

REFRESHING

High-School Mathematics

and beyond..

Numbers and symbols

Symbolic and numeric calculations

Physics students have to be able to operate with symbols (such as a , b , x , y , Q , etc.) that stand for numbers. Calculations should be done, as a rule, in a symbolic form, and the analytical (that is, symbolic) result should be obtained. Only after that concrete numbers should be plugged into the analytical result, to obtain the numerical result. Doing this is not a big problem since all operations on numbers can be done on symbols as well. Symbolic operations have important advantages, however, such as better overview of the manipulations, possibility of backtracking and checking, possibility of using multiple sets of numerical values without a necessity of doing similar calculations many times, possibility of operating with quantities, numerical values of which are unknown but irrelevant.

Basic identities

$$a + b = b + a$$

$$a + (b + c) = (a + b) + c = (a + c) + b = a + b + c$$

$$ab = ba$$

$$a(bc) = (ab)c = (ac)b = abc = acb = bca = \dots$$

$$a(b + c) = ab + bc$$

$$(a + b)^2 = a^2 + 2ab + b^2 \text{ (binomial formula)}$$

(operations in brackets are performed first)

Fractions

$$a/b = \frac{a}{b} = a \frac{1}{b} = a \times b^{-1}$$

$$a \frac{b}{c} = \frac{b}{c} a = \frac{ab}{c} = ab \frac{1}{c} = ab/c$$

$$\frac{a}{b} \frac{c}{d} = \frac{ac}{bd}$$

$$\frac{a}{b} + \frac{c}{d} = \frac{ad}{bd} + \frac{bc}{bd} = \frac{ad + bc}{bd}$$

Inserted for convenience

Compound Fractions

Fractions containing fractions are sometimes confusing, such as

$$\frac{\frac{a}{b}}{c} \quad \text{or} \quad \frac{\frac{a}{c}}{b}$$

To avoid confusion, we can distinguish between external and internal fractions and make external fractions longer and/or bolder. If we divide

$$a \quad \text{or} \quad \frac{a}{b} \quad \text{over} \quad \frac{c}{d}$$

we write

$$\frac{\frac{a}{b}}{c} \quad \frac{\frac{a}{b}}{\frac{c}{d}} \quad \begin{array}{l} \leftarrow \text{internal fractions} \\ \leftarrow \text{external fraction} \end{array}$$

and simplify the fractions as follows

$$\frac{\frac{a}{b}}{c} = \frac{ac}{b} \quad \frac{\frac{a}{b}}{\frac{c}{d}} = \frac{ad}{bc}$$

Manipulations above can be justified using powers instead of reciprocals:

$$\frac{\frac{a}{b}}{c} = a \left(\frac{b}{c} \right)^{-1} = a \frac{c}{b} = \frac{ac}{b}$$

$$\frac{\frac{a}{b}}{\frac{c}{d}} = \frac{a}{b} \left(\frac{c}{d} \right)^{-1} = \frac{a}{b} \frac{d}{c} = \frac{ad}{bc}$$

Fractions can also be written as

$$\frac{a}{b} = a / b$$

Expression a/bc can be confusing. If the writer means $a/(bc)$, it should be written explicitly so. Otherwise it means

$$a / bc = (a / b)c = \frac{a}{b} c = \frac{ac}{b} = ac / b$$

according to all programming languages.

Exponents

Products of several equal numbers can be represented by powers of these numbers, such as

$$\underbrace{a \times a \times \dots \times a \times a}_{b \text{ times}} = a^b$$

Here b is the exponent and a is the base. Bases and exponents can be, in fact, any numbers, not necessary natural. In particular, negative exponents are used for reciprocals, such as

$$a^{-b} = \frac{1}{a^b}$$

and fractional exponents represent roots

$$a^{1/2} = \sqrt{a}$$

Properties of powers:

$$a^m a^n = a^{m+n}$$

$$(a^m)^n = a^{nm}$$

$$a^1 = a, \quad a^0 = 1$$

Examples:

$$\frac{3 \times 5 \times 3 \times 5 \times 3}{5 \times 3 \times 5 \times 5} = 3^{3-1} 5^{2-3} = 3^2 5^{-1}$$

$$(\sqrt{2})^2 = (2^{1/2})^2 = 2^{1/2 \times 2} = 2^1 = 2$$

$$\sqrt{2^2} = (2^2)^{1/2} = 2^{2 \times 1/2} = 2^1 = 2$$

Scientific notation for numbers

In physics one has frequently to deal with very large and very small numbers. The best way to write these numbers is using the scientific notation. For instance, the scientific notation for 12345.678 is 1.2345678×10^4 . The exponent 4 shows that we have moved the decimal point by 4 positions to the left. Here one sees more clearly how large the number is, its order of magnitude is 10^4 . For this reason, the factor in front (the so-called simple part) should be kept maximally close to 1. The number 9123.456 is better to write as 0.9123456×10^4 than as 9.123456×10^3 because the order of magnitude of this number is 4 and not 3. Similarly the number 0.000001234 is written in the scientific notation as 1.234×10^{-6} , where the exponent -6 shows that we have moved the decimal point by six positions to the right. Remember that negative powers describe reciprocals, so that in this case we divide 1.234 by 10 six times.

Example: The mass of electron m_e is approximately 0.911×10^{-30} kg, difficult to write in the usual notation!

When several numbers are multiplied or divided, one can operate the simple parts and powers of 10 independently:

$$\frac{1.2 \times 10^5 \times 3.4 \times 10^7 \times 0.68 \times 10^{-21}}{0.56 \times 10^{12} \times 4.4 \times 10^{-30}} = \frac{1.2 \times 3.4 \times 0.68}{0.56 \times 4.4} 10^{5+7-21-12+30} = 1.13 \times 10^9$$

For an order-of-magnitude estimation, you can simplify the task and drop all simple parts, that yields 10^9 in the example above.

Algebraic equations

Solving physical problems usually involves solving algebraic equations and systems of equations. In most cases these equations are linear.

An example of a linear equation (usually we use a, b, c, \dots for knowns and x, y, z, \dots for unknowns):

$$ax + b = c$$

Equations remain valid if the same quantity is added or subtracted to their right-hand side (rhs) and left-hand side (lhs) and if both rhs and lhs are multiplied or divided by the same quantity. This can be used to isolate unknowns in one of the sides of the equation, that is to solve the equation. For the equation above it is done in the following way:

$$ax + b = c \Rightarrow ax + b - b = c - b \Rightarrow ax = c - b \Rightarrow \boxed{x = \frac{c - b}{a}}$$

(Frame your final result!)

Solving physical problems, we use standard notations adopted in physics rather than just a, b, c and x, y, z . One should understand which quantities are known and which are unknown. If, for instance, acceleration a has to be found from Newton's second law $F = ma$, then we consider a as the unknown and solve the algebraic equation as follows:

$$F = ma \Rightarrow \boxed{a = \frac{F}{m}}$$

The framed expression is our final symbolic, or so-called analytical, result. We now plug numerical values for F and m into it and obtain our final numerical result for a .

Systems of algebraic equations

In many cases one has to solve systems of linear algebraic equations such as

$$a_1x + b_1y = c_1$$

$$a_2x + b_2y = c_2$$

where x and y are unknowns. One of different ways to do it is, say, to

- (i) find y from the first equation;
- (ii) plug the result into the second equation;
- (iii) solve the second equation for x ;
- (iv) plug the result for x into the expression for y obtained in (i)

that is

$$a_1x + b_1y = c_1 \Rightarrow y = \frac{c_1 - a_1x}{b_1}$$

$$a_2x + b_2y = c_2 \Rightarrow a_2x + b_2 \frac{c_1 - a_1x}{b_1} = c_2 \Rightarrow \left(a_2 - a_1 \frac{b_2}{b_1} \right) x + c_1 \frac{b_2}{b_1} = c_2$$

$$\Rightarrow x = \frac{c_2 - c_1 \frac{b_2}{b_1}}{a_2 - a_1 \frac{b_2}{b_1}} = \boxed{\frac{c_2 b_1 - c_1 b_2}{a_2 b_1 - a_1 b_2}} = x \quad \text{(do not forget to simplify your results!)}$$

and then we perform (iv) that after simplification yields

$$\boxed{y = \frac{c_2 a_1 - c_1 a_2}{b_2 a_1 - b_1 a_2}}$$

Remember that in a well-behaved system of equations the number of unknowns is equal to the number of equations. You should always perform the count of unknowns and equations before you start with solving a system of equations.

Lines, Angles, and Triangles

1) Angles are the same if

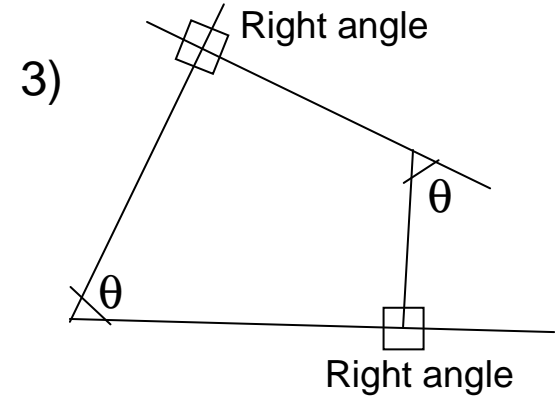
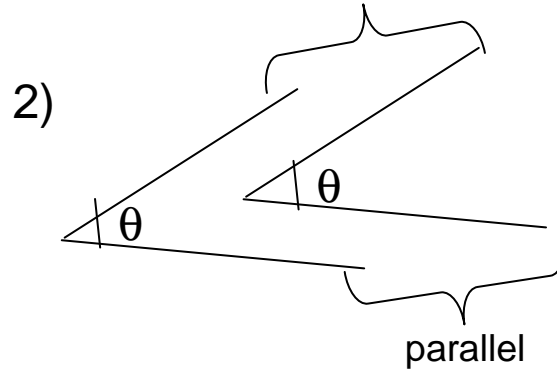
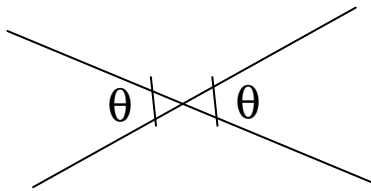

Example

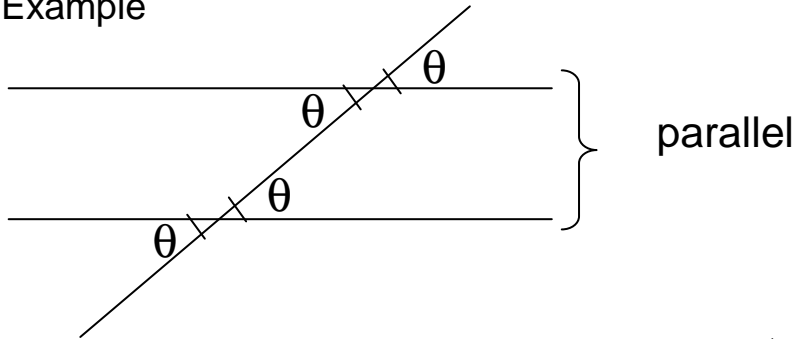

Similar triangles

$$\frac{a_1}{b_1} = \frac{a_2}{b_2} = \frac{a_3}{b_3}$$

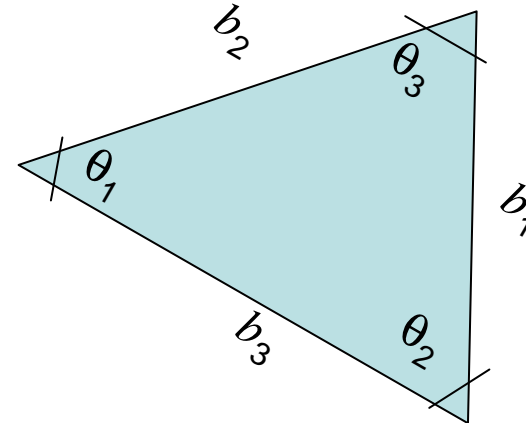
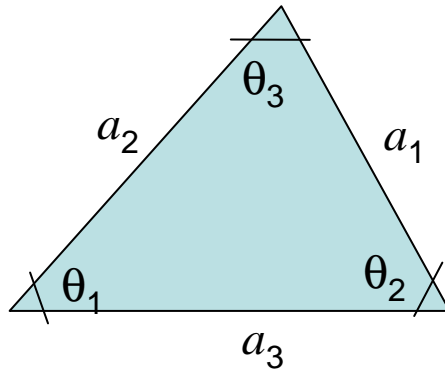

Angles

Angles are usually denoted by Greek letters such as $\alpha, \beta, \theta, \varphi$, etc.

Angles can be measured in

- degrees (seldom used in physics)
- revolutions (360°) (used in engineering)
- radians (mostly used in physics)

Radian is such an angle, for which the length of the arc is equal to the radius. In other words, the angle in radians is given by L/R and it is dimensionless.

Revolution corresponds to $L = 2\pi R$, thus $360^\circ = 2\pi$ radians and

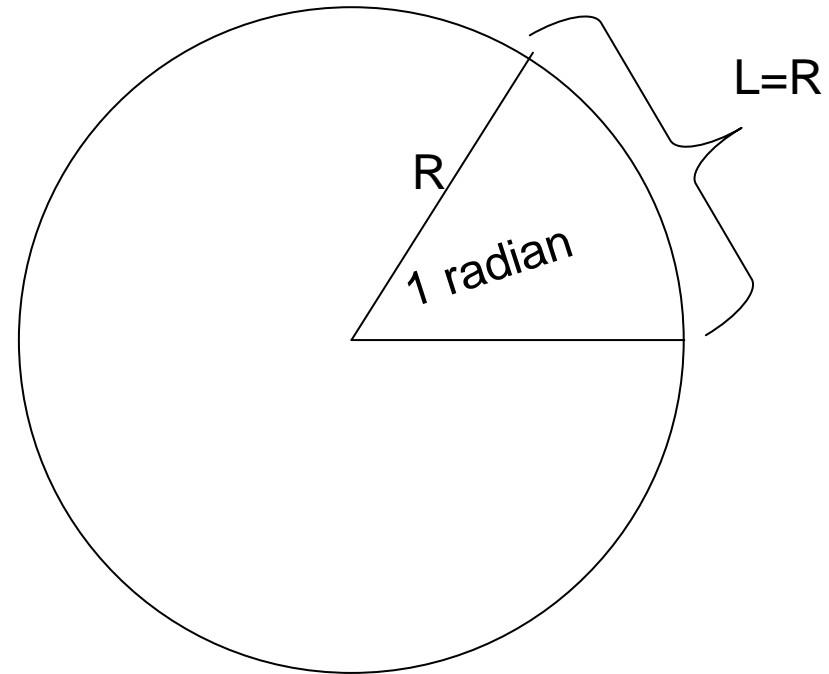

$$1 \text{ radian} = 360^\circ / (2\pi) = 57.3^\circ$$

$$1 \text{ revolution} = 360^\circ = 2\pi \text{ radian}$$

Trigonometric functions

Properties of triangles with right angle ($\gamma = \pi/2$):

$$\theta + \theta' = \pi/2 = 90^\circ$$

$$c^2 = a^2 + b^2 \quad (\text{Pythagoras theorem})$$

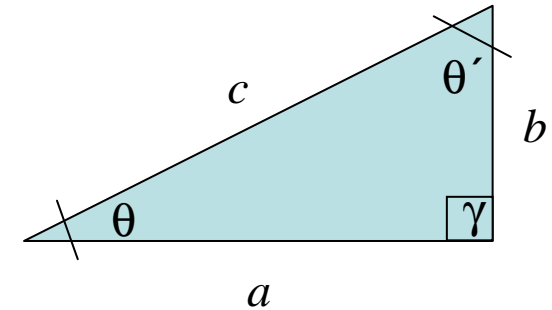

For these triangles one defines trigonometric functions as follows:

$$\sin \theta = \frac{b}{c} = \frac{b}{\sqrt{a^2 + b^2}}, \quad \cos \theta = \frac{a}{c} = \frac{a}{\sqrt{a^2 + b^2}}, \quad \tan \theta = \frac{b}{a} = \frac{\sin \theta}{\cos \theta}, \quad \cot \theta = \frac{a}{b} = \frac{\cos \theta}{\sin \theta} = \frac{1}{\tan \theta}$$

sin and cos are called, as a group, sinusoidal functions. They satisfy

$$\sin^2 \theta + \cos^2 \theta = 1$$

On the other hand, one can define trigonometric functions for the angle θ' of the triangle in the same way:

$$\sin \theta' = \frac{a}{c} = \frac{a}{\sqrt{a^2 + b^2}}, \quad \cos \theta' = \frac{b}{c} = \frac{b}{\sqrt{a^2 + b^2}}, \quad \tan \theta' = \frac{a}{b}, \quad \cot \theta' = \frac{b}{a}$$

Comparison with the above yields

$$\sin \theta' = \sin\left(\frac{\pi}{2} - \theta\right) = \cos \theta, \quad \cos \theta' = \cos\left(\frac{\pi}{2} - \theta\right) = \sin \theta, \quad \tan \theta' = \tan\left(\frac{\pi}{2} - \theta\right) = \cot \theta, \quad \dots \quad 11$$

Above we have defined trigonometric functions with the help of triangles, so that θ is limited to the interval $0 \leq \theta \leq \pi/2$. One can, however, define trigonometric functions for arbitrary arguments with the help of components of a two-dimensional unit vector \mathbf{n} ($|\mathbf{n}| = 1$) as follows

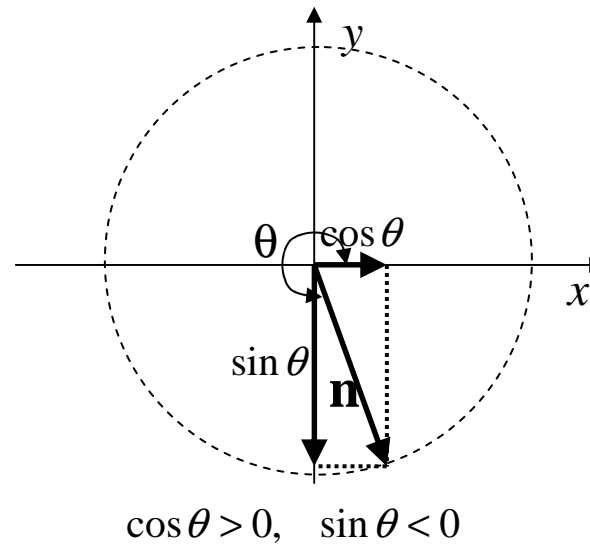
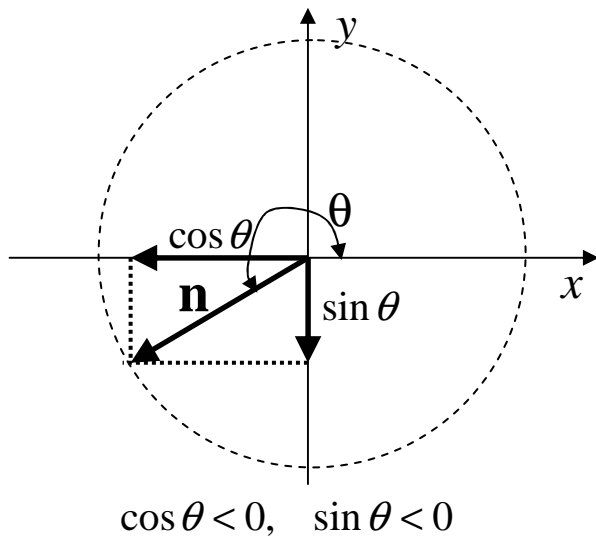
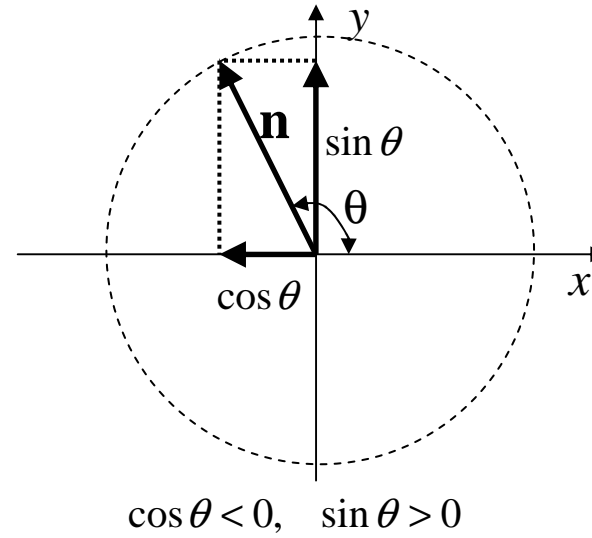
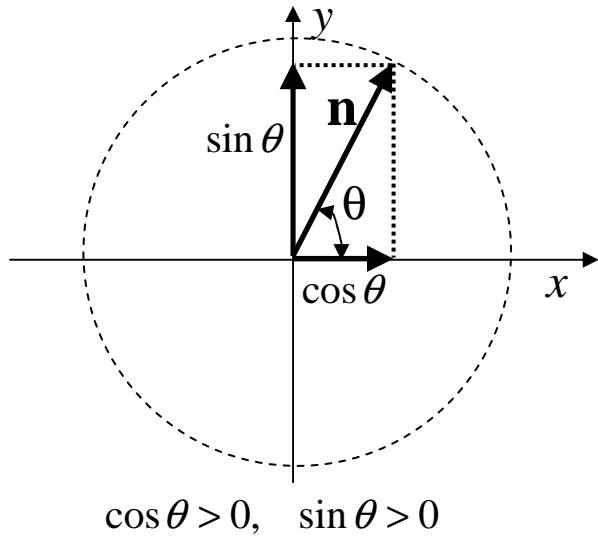

Trigonometric functions are periodic with period 2π :

sin and cos differ by an argument shift and there are a lot of corresponding relations

Symmetry:

$$\cos(-\theta) = \cos \theta$$

$$\sin(-\theta) = -\sin \theta$$

$$\tan(-\theta) = -\tan \theta$$

$$\cot(-\theta) = -\cot \theta$$

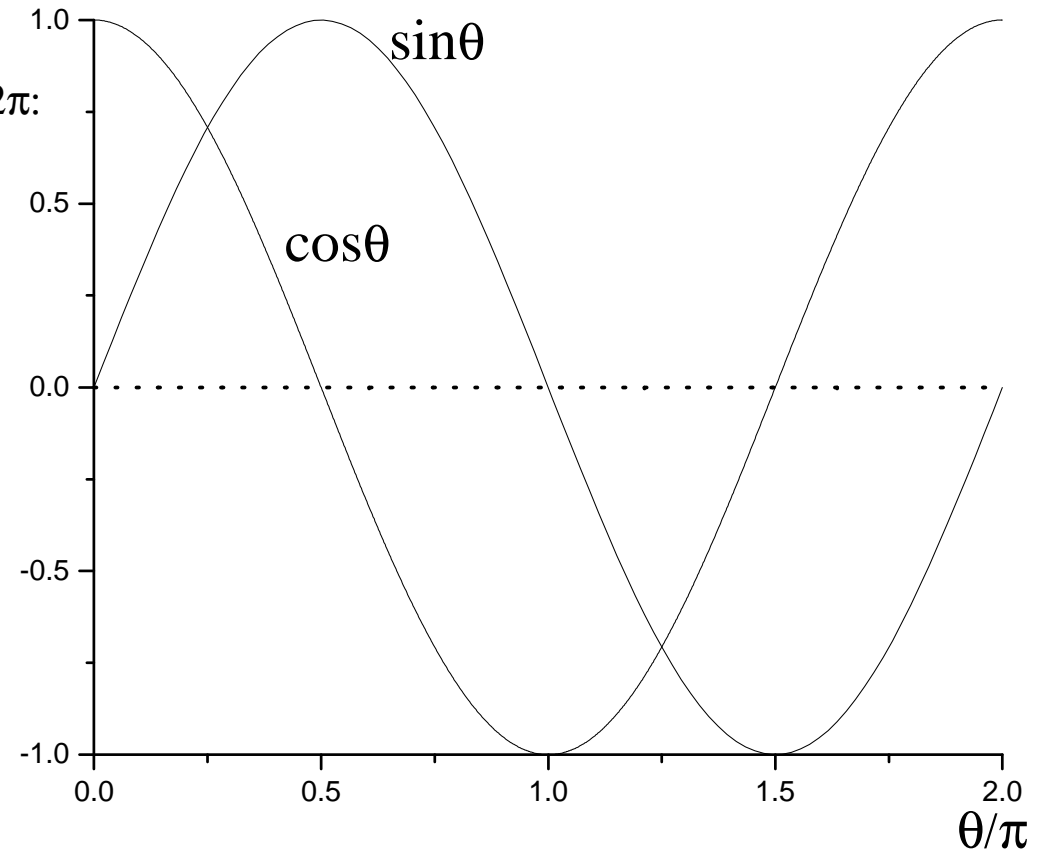

Inverse trigonometric functions

$$\sin \theta = x \Rightarrow \theta = \arcsin x$$

$$\cos \theta = x \Rightarrow \theta = \arccos x$$

$$\tan \theta = x \Rightarrow \theta = \arctan x$$

$$\cot \theta = x \Rightarrow \theta = \text{arccot } x$$

Scalars and Vectors

Most of the physical quantities are scalars or vectors.

Scalars are objects that are represented by numbers, such as time t , mass m , electric charge q or Q , temperature t or T . Some scalar quantities are always positive or nonnegative, such as mass m , volume V , kinetic energy E_k , absolute temperature T , etc. Most of scalar quantities can be either positive or negative, such as electric charge q or Q , time t , etc.

Vectors are mathematical and/or physical objects that are characterized by (i) their magnitude or absolute value or length and (ii) their direction in space. Many physical quantities are vectors, such as position, velocity, force, electric and magnetic fields, etc. Vectors can be added, subtracted, and multiplied. Vectors can be divided by a scalar but one cannot divide by vector. Vectors are denoted by symbols with overhead arrows (\vec{A}) in handwritten texts and by boldface symbols (\mathbf{A}) in printed texts.

Magnitude (length) of a vector \mathbf{A} is denoted as $|\mathbf{A}|$ or simply as A . Vectors of unit length, $|\mathbf{A}| = 1$, describe directions. Each vector can be represented in the form $\mathbf{A} = A\mathbf{n}$, where $A > 0$ and \mathbf{n} is a unit vector directed along \mathbf{A} .

Addition of vectors can be done graphically with the help of either the tail-to-tip rule or the parallelogram rule

$$\mathbf{A} + \mathbf{B} = \mathbf{C}$$

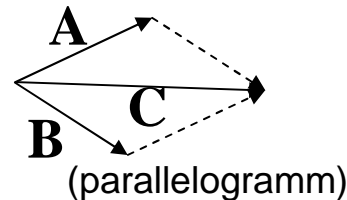
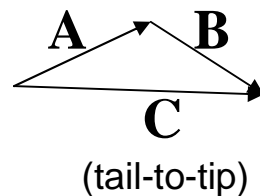

Subtraction of vectors:

$$\mathbf{A} - \mathbf{B} = \mathbf{C}$$

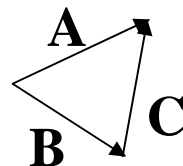

because $\mathbf{A} = \mathbf{B} + \mathbf{C}$

Vectors and Coordinate Systems

To perform operations on vectors numerically, it is convenient to introduce a coordinate system. The latter is defined by the origin O and three mutually perpendicular axes x , y , and z . The tail of the vector \mathbf{A} is in the origin of the coordinate system. We project the vector \mathbf{A} onto the axes of the coordinate system by drawing the three lines from its tip towards all three axes perpendicularly to the latter. As the result, \mathbf{A} is represented as the sum of three vectors:

$$\mathbf{A} = \mathbf{A}_x + \mathbf{A}_y + \mathbf{A}_z = A_x \mathbf{e}_x + A_y \mathbf{e}_y + A_z \mathbf{e}_z$$

Here we have introduced the unit vectors \mathbf{e}_x , \mathbf{e}_y , and \mathbf{e}_z , ($|\mathbf{e}_x| = 1$ etc.) that are directed along different axes. The scalar quantities A_x , A_y and A_z are components of the vector \mathbf{A} in this coordinate system or its projections on the axes of this coordinate system. Note that components of a vector can be both positive and negative.

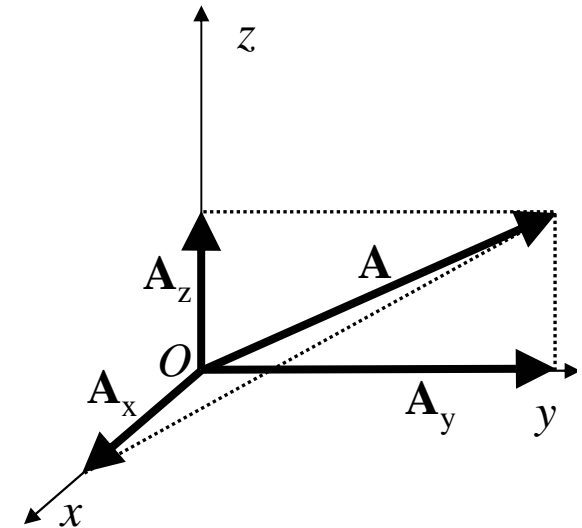

With the above definitions, one obtains many useful formulas. Addition of vectors can be done as

$$\mathbf{A} + \mathbf{B} = A_x \mathbf{e}_x + A_y \mathbf{e}_y + A_z \mathbf{e}_z + B_x \mathbf{e}_x + B_y \mathbf{e}_y + B_z \mathbf{e}_z = (A_x + B_x) \mathbf{e}_x + (A_y + B_y) \mathbf{e}_y + (A_z + B_z) \mathbf{e}_z$$

$$\mathbf{A} + \mathbf{B} = \mathbf{C} = C_x \mathbf{e}_x + C_y \mathbf{e}_y + C_z \mathbf{e}_z \quad \Rightarrow \quad \boxed{C_x = A_x + B_x, \quad C_y = A_y + B_y, \quad C_z = A_z + B_z}$$

That is, to add vectors, one has just to add their components, and similar for subtraction.

Multiplication or division of a vector by a positive scalar changes its length but does not change its direction. If \mathbf{A} is a vector and $\varphi > 0$ is a scalar, then $\mathbf{B} = \varphi\mathbf{A} = \varphi A\mathbf{n} = B\mathbf{n}$, that is, $B = \varphi A$. Multiplication of a vector by a negative scalar additionally inverts its direction. In components one obtains

$$\mathbf{B} = \varphi\mathbf{A} = \varphi A_x \mathbf{e}_x + \varphi A_y \mathbf{e}_y + \varphi A_z \mathbf{e}_z = B_x \mathbf{e}_x + B_y \mathbf{e}_y + B_z \mathbf{e}_z$$

thus one has simply to multiply components of the vector by the scalar: $B_x = \varphi A_x$, etc., for both signs of φ .

The length of a vector can be obtained in components from the Pythagoras theorem:

$$A = |\mathbf{A}| = \sqrt{A_x^2 + A_y^2 + A_z^2}$$

Using trigonometric functions, one can express components (projections) of a vector as

$$A_x = A \cos \alpha, \quad A_y = A \cos \beta, \quad A_z = A \cos \gamma$$

where α , β , and γ are the angles between vector \mathbf{A} and the axes x , y , and z , respectively. In particular, for a vector that is confined to a plane (that is, has only two components) one has

$$A_x = A \cos \theta, \quad A_y = A \sin \theta = A \cos \theta'$$

